

Red Laser Diode

Application

Industrial use / Biomedical

Property

Wavelength $\lambda = 650\text{nm}$

Output Power = 5mW

Package Type = $\varphi 5.6\text{mm}$

Introduction

Egismos currently markets AlGaInP based red laser diodes in the 635nm ~ 670nm wavelengths range. The low operating current and high temperature of the laser diodes are achieved through using misoriented substrate and MQW (Strain compensated) active layer.

Egismos laser diodes are highly rated in a broad range of applications including, but not limited to, laser pointers, green lasers, blue laser DVD, laser barcode scanners, diode laser equipments, medical instruments and aerospace applications.



Red Laser Diode Key features

Absolute Maximum Rating at Tc=25°C

Items	Symbols	Values	Unit
Optical Output Power	Po(CW)	5	mW
Reverse Voltage	V	2	V
Operating Temperature	To	-10~+50	°C
Storage Temperature	Ts	-10~+70	°C

Electrical and Optical Characteristics at Tc=25°C

Item	Symbols	Min	Typ.	Max.	Unit	Condition
Optical Output Power	Po	-	-	5	mW	-
Threshold Current	Ith	-	21	30	mA	-
Operating Current	Iop	-	28	40	mA	Po=5mW
Operating Voltage	Vop	-	2.2	2.6	V	Po=5mW
Peak Wavelength	λ_p	640	650	660	nm	Po=5mW

Beam Divergence	$\theta_{//}$	6	8	12	deg	Po=5mW
	θ_{\perp}	22	32	38	deg	Po=5mW

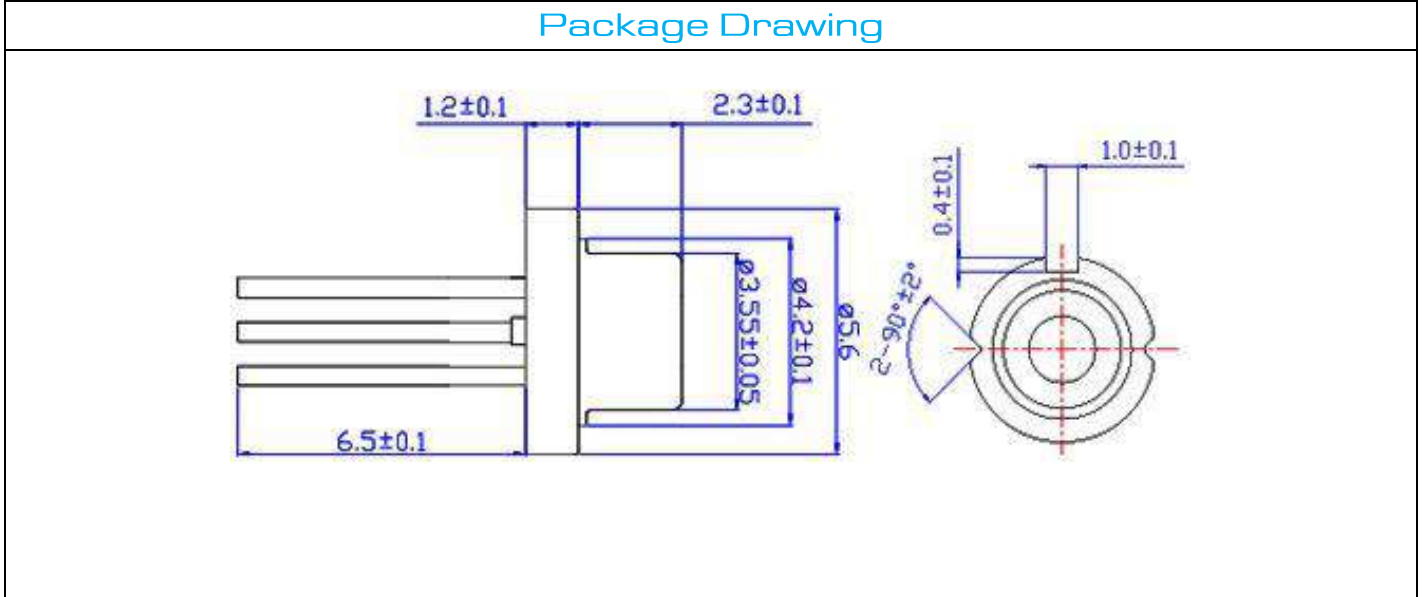
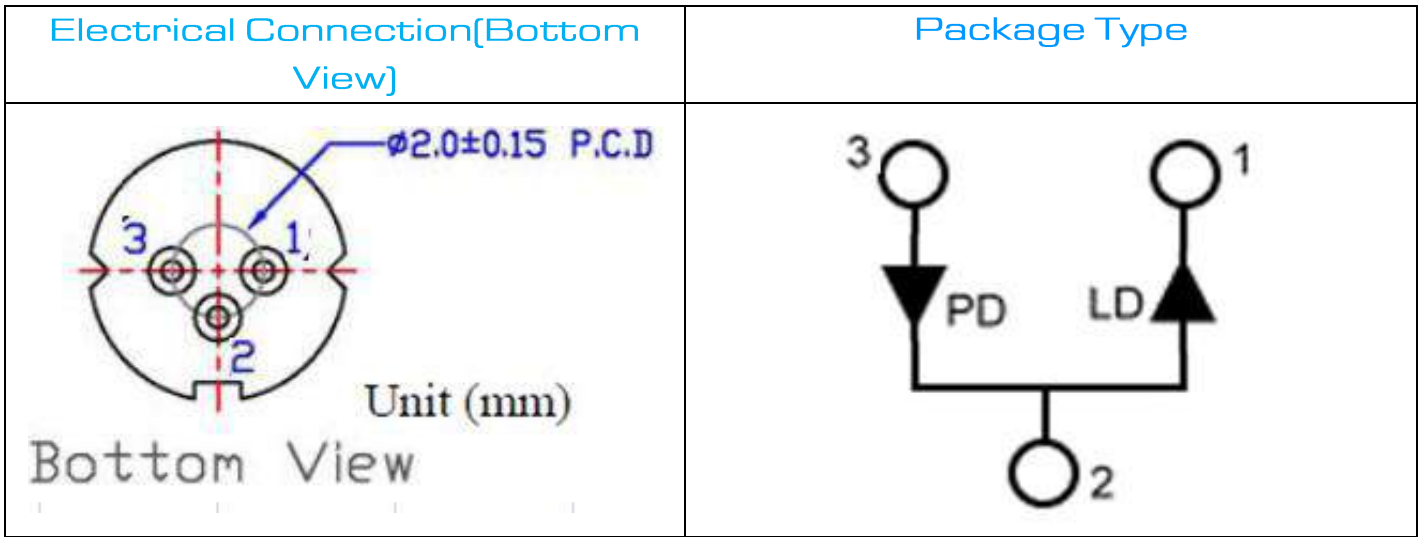

Specifications are subject to change without notice.

