

D6-4-980-50

Key features

Invisible Light $\lambda = 850\text{nm}$
Output Power = 50mW
Package Type = 5.6mm Φ

Applications

General Purpose Infrared Laser Light Source
Optical Communication & Infrared Laser Module for Industry Application

Electrical and Optical Characteristics at $T_c=25^\circ\text{C}$

Item	Symbols	Min.	Typ.	Max.	Unit	Condition
Optical Output Power	Po	-	50	-	mW	-
Threshold Current	Ith	-	20	40	mA	Po=50mW
Operating Current	Iop	-	75	100	mA	Po=50mW
Monitor Current	Im	-	0.25	-	mA	Po=50mW
Operating Voltage	Vop	-	1.9	2	V	Po=50mW
Peak Wavelength	λ_p	842	852	862	nm	Po=50mW
Beam Divergence	$\theta_{//}$	6	9	12	deg	Po=50mW
	θ_{\perp}	18	22	26	deg	Po=50mW

EGISMOS IR Laser Diode

Absolute Maximum Rating at Tc=25°C

Items	Symbols	Values	Unit
Optical Output Power	Po(CW)	50	mW
Laser Diode Reverse Voltage	V	2	V
Photo Diode Reverse Voltage	V	30	V
Operating Temperature	To	-10~+60	°C
Storage Temperature	Ts	-40~+85	°C

Electrical Connection

Package Type

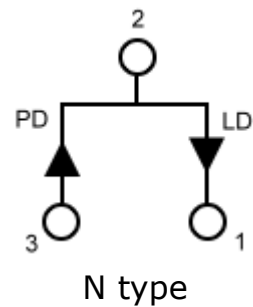
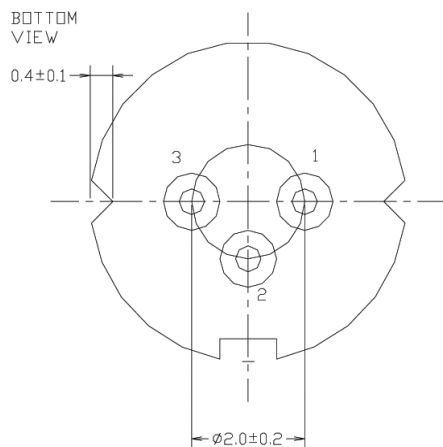

Package Drawing

