

## Fiber Coupled Laser Module

### Application

Industrial areas / Medical / Biochemical

### Property

Wavelength Range = 850nm

Silica Fiber Cable

### Introduction

Egismos is producing high stability and quality fiber coupled laser modules that are successfully applied in industry, biochemistry and medical equipment. Fiber coupled laser module series is distinguished by its small size, high transmission rate and competitive price.



### Laser Specification :

Specifications(T=25°C)	Symbol	FC850SC40-S100A1M	
Output Mode		Multi-mode	
Wavelength	nm	Typ 850	840~860
Optical out power	mW	Typ 40	35~45
Operating Voltage	V	Typ 3.0	2.8~3.5
Operating Current	mA	Typ 65	Max 80
Operating Temperature	°C	Typ 25	-10~+50
Storage Temperature	°C	-40~+85	
Storage Humidity	%	0~90	
Proof Test	kpsi	100	
Housing Material		Brass/Aluminum	
Mean time to failure(MTTF)	hrs	>8,000	
Numerical Aperture(N.A.)		0.22	

## Fiber patch cable Specification :

Specifications	Symbol	FC850SC40-S100A1M	FC850SC40- S200A1M
Fiber Pigtail Length	m	1	1
Fiber Core Diameter	D( $\mu\text{m}$ )	100	200
Core Non-Circularity	%	$\leq 5$	$\leq 5$
Fiber Core Material		HCS Silica	HCS Silica
Attenuation Values	dB/km	$\leq 6@850\text{nm}$	$\leq 6@850\text{nm}$
Core/Cladding Concentricity	$\mu\text{m}$	$\leq 3$	$\leq 3$
Cladding Diameter	$\mu\text{m}$	140	230
Cladding Non-Circularity	%	$\leq 2$	$\leq 2$
Coating Diameter	$\mu\text{m}$	250	500
Connector(Optional)		SMA905	SMA905
Fiber Bend Radius	mm	$\geq 100 D$ (short time ) $\geq 300 D$ (long time )	$\geq 100 D$ (short time ) $\geq 300 D$ (long time )
Jacket Diameter	mm	0.9 mm	0.9 mm
Cable Jacket	mm	3 (PVC)	3 (PVC)

## Specification chart :

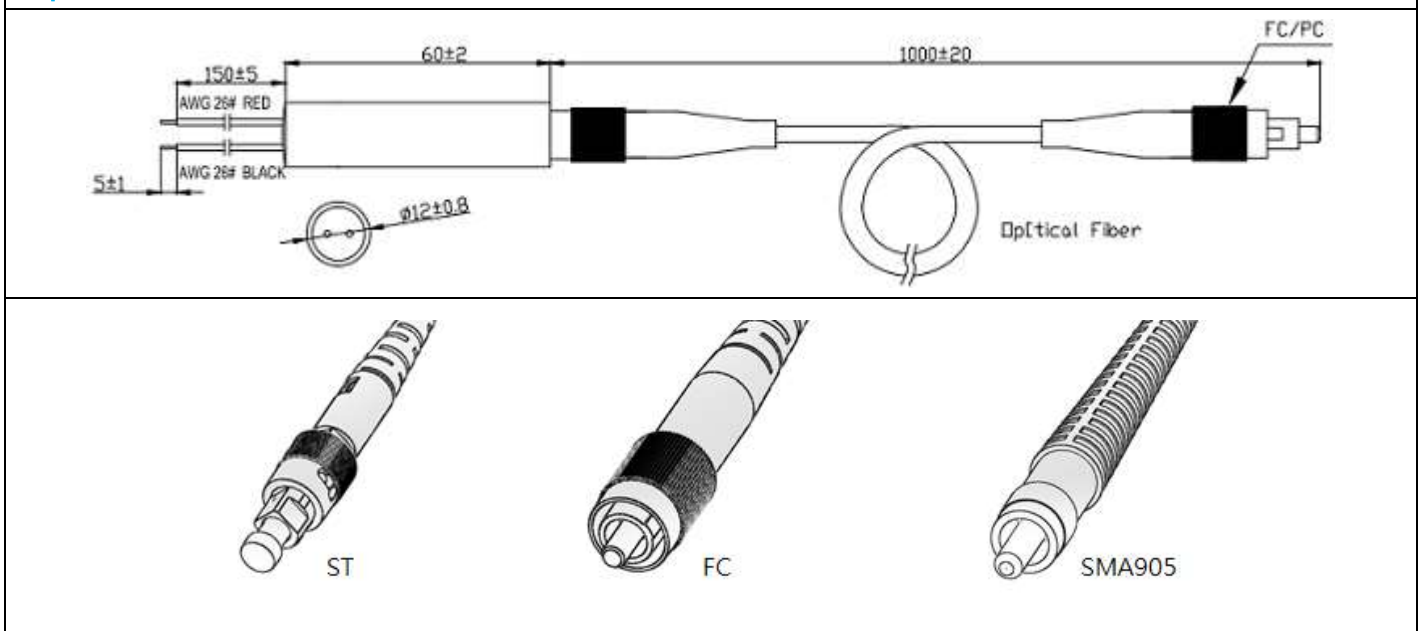

### Mean Time to Failure (MTTF)

Mean time to failure (MTTF) is the length of time a device or other product is expected to last in operation. MTTF is one of many ways to evaluate the reliability of pieces of hardware or other technology. It's important to note, however, that the mean time to failure metrics provided by companies regarding specific products or components may not have been collected by running one unit continuously until failure. Instead, MTTF data is often collected by running many units, even many thousands of units, for a specific number of hours.

### Numerical Aperture

In optics, the numerical aperture (NA) of an optical system is a dimensionless number that characterizes the range of angles over which the system can accept or emit light. By incorporating index of refraction in its definition, NA has the property that it is constant for a beam as it goes from one material to another provided there is no optical power at the interface. The exact definition of the term varies slightly between different areas of optics. Numerical aperture is commonly used in microscopy to describe the acceptance cone of an objective (and hence its light-gathering ability and resolution), and in fiber optics, in which it describes the range of angles within which light that is incident on the fiber will be transmitted along it.

### Bend Radius

Bend radius, which is measured to the inside curvature, is the minimum radius one can bend a pipe, tube, sheet, cable or hose without kinking it, damaging it, or shortening its life. The smaller the bend radius, the greater is the material flexibility.

Specifications are subject to change without notice.

